

- P 6**
- 1 LINE a
 - 2 LINE b
 - 3 SCREEN
 - 4 LINE a
 - 5 LINE b
 - 6 SCREEN
 - 7 P-FILTER OUT
 - 8 P-FILTER IN
 - 9 OVA
 - 10 X
 - 11 LINE a
 - 12 LINE b
 - 13 SCREEN
 - 14 LINE a
 - 15 LINE b
 - 16 SCREEN
 - 17 X
 - 18 USER
 - 19 USER
 - 20 USER
 - 21 X
 - 22 CH 1 PAN/BAL
 - 23 OV INT.
 - 24 CH 2 PAN/BAL
 - 25 AF OUT
 - 26 OVA
 - 27 PF-OUT
 - 28 OVA
 - 29 P-FILTER OUT
 - 30 P-FILTER IN
 - 31 LINE SIGN. 1
 - 32 LINE SIGN. 2

- P 4**
- 1 MASTER SIGN.
 - 2 OVERLOAD
 - 3 -6V
 - 4 OVL
 - 5 -15V
 - 6 OVA
 - 7 +15V
 - 8 -24V
 - 9 X
 - 10 MPX
 - 11 X
 - 12 GEN. a
 - 13 GEN. b
 - 14 X
 - 15 AUX 4-R OUT
 - 16 AUX 4-L OUT
 - 17 AUX 3 OUT
 - 18 AUX 2 OUT
 - 19 AUX 1 OUT
 - 20 OVA
 - 21 ≈ 8 OUT
 - 22 ≈ 6 OUT
 - 23 ≈ 4 OUT
 - 24 ≈ 2 OUT
 - 25 OV REF
 - 26 ≈ 1 OUT
 - 27 ≈ 3 OUT
 - 28 ≈ 5 OUT
 - 29 ≈ 7 OUT
 - 30 PFL-SIGN. BUS
 - 31 PFL/P-SOLO R
 - 32 PFL/P-SOLO L

- P 3**
- 1 PFL-SIGN. BUS
 - 2 FADER OUT L
 - 3 OVA R
 - 4 FADER OUT R
 - 5 -24V
 - 6 +15V
 - 7 OVA
 - 8 -15V
 - 9 OVL
 - 10 X
 - 11 -6V
 - 12 PFL CONTR.
 - 13 OVA
 - 14 +15V
 - 15 -24V
 - 16 FADER IN R
 - 17 OVA L
 - 18 FADER IN L
 - 19 CH-OFF

- P 2**
- 1 CH-OFF
 - 2 FADER IN L
 - 3 OVA L
 - 4 FADER IN R
 - 5 P-SOLO CONTR.
 - 6 PFL CONTR.
 - 7 -6V
 - 8 OVL
 - 9 -15V
 - 10 OVA
 - 11 +15V
 - 12 -24V
 - 13 FADER OUT R
 - 14 OVA R
 - 15 FADER OUT L
 - 16 PFL-SIGN. BUS

Q 401, 204 = J 111
 Q 402 113
 Q 202 213 J 112
 J 301, 302, 304

* 4 CH FILTER : 1.912.240
 4 CH : 1.912.241
 ** 8 CH FILTER : 1.912.242
 *** 8 CH : 1.912.243

Δ 8 CH VERSION NOT EQUIPPED
 □ FILTER VERSION REPLACED BY LINK
 # WITHOUT FILTER " " "

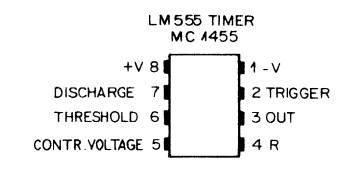
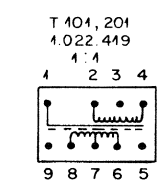
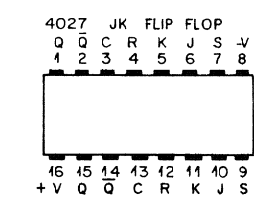
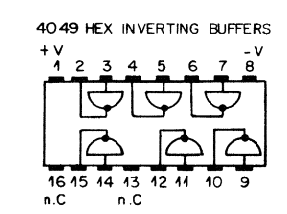
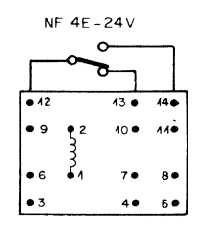
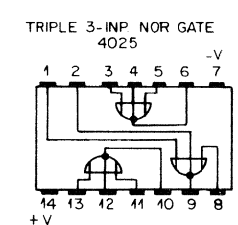
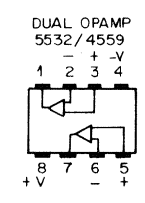
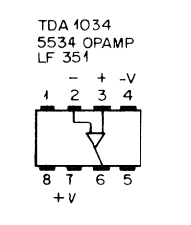

BOTTOM VIEW

DATE	11.12.84	11.4.85			
SIGN	ml	ml			
DATE	9.5.83	26.2.84	11.5.84	6.9.84	4.10.84
SIGN	ml	ml	ml	ml	ml
STUDER REGENSDORF ZURICH					PAGE 3 OF 3
HL STEREO INPUT UNIT A 4CH/FILTER					1.912.240...243

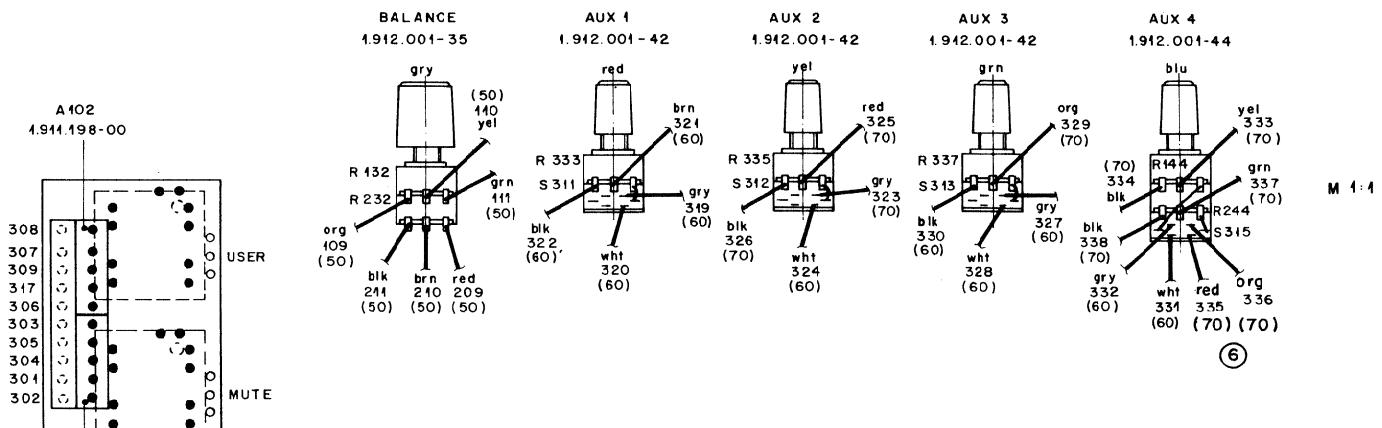

⑤

WIRINGDIAGRAM FOR FILTER VERSION

UNIT	EQ BOARD			
1.912.240-00	1.912.291-00			
104	405	gry	FILTER OUT	L
105	400	blk	⊥	L
106	406	wht	FILTER IN	L
107	441	grn	SPREAD IN	L
108	446	gry	SPREAD OUT	L
204	505	brn	FILTER OUT	R
205	500	blk	⊥	R
206	506	wht	FILTER IN	R
207	541	wht	SPREAD IN	R
208	546	brn	SPREAD OUT	R
343	541	blk	OV	
344	540	red	+15 V	
345	542	blu	-15 V	

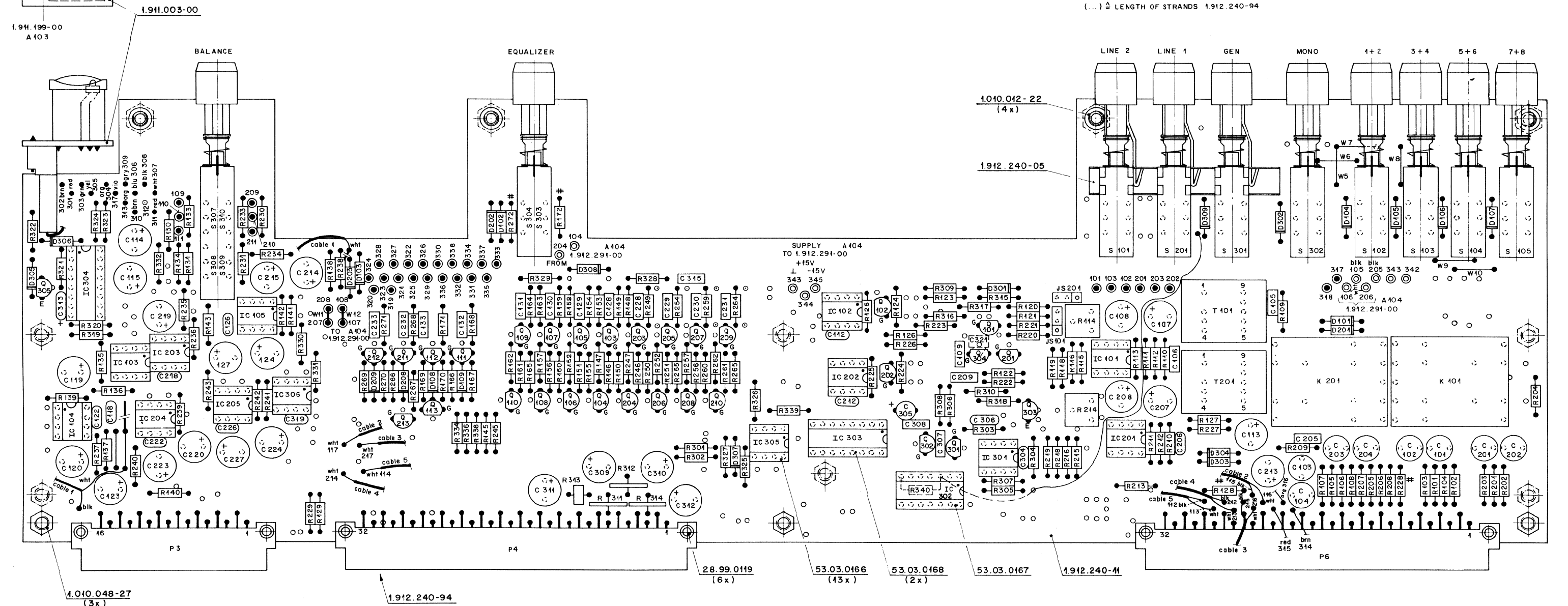
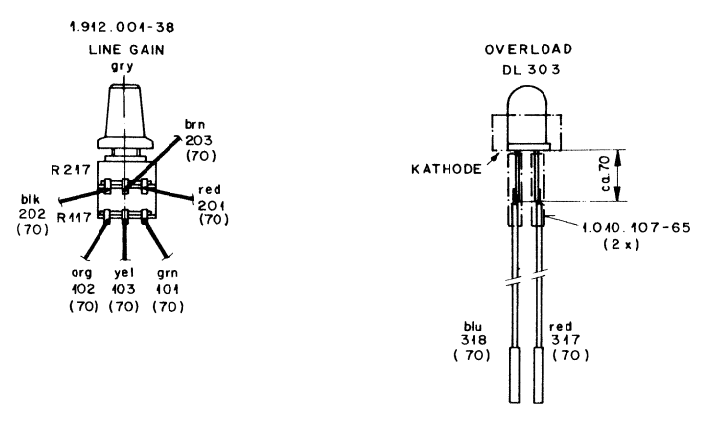

④ # In der Version mit Filter (1.912.240/242-00) müssen R172/R272 (1k Ω) bestückt werden. R128/R228 müssen durch Brücken ersetzt werden.

In der Version ohne Filter (1.912.241/243-00) müssen R172/R272 durch Brücken ersetzt werden. R128/R228 (33 Ω) müssen bestückt werden.

// Leiterbahn auf Bestückungsseite aufgelötet

① # FILTER VERSION : R172 REPLACED (OPTION 1)
 W1 R272
 W2 " "
 W3 W4
 W4 " "

ONLY 4CH : W5, W6, W7, W8
 ONLY 8CH : W6, W7, W9
 W6 ONLY USED WITH PCB 1.912.240-11 INDEX 0

④ // CIRCUIT INTERRUPT COMPONENTSIDE

VALID FOR	NR. UNIT	PL	EQUALIZER
4CH FILTER	1.912.240-00	1.912.240-00	1.912.291-00
4CH	1.912.241-00	1.912.240-00	—
8CH FILTER	1.912.242-00	1.912.240-00	1.912.291-00
8CH	1.912.243-00	1.912.240-00	—

Norm-Nr.:	Güte:	28.885	A.Ho	⑥
DIN-Bez.:	Beh.:	M.4.85	A.Ho	⑤
Abmessung:	Änderung:	11.12.84	A.Ho	④
Zugehörige Unterlagen:	Freimasstoleranz:	6.9.84	R.Be	③
*	±	9.2.84	A.Ho	②
Ersetzt für:	Ersetzt durch:	23.9.83	A.Ho	①
Kopie für:		Datum	Gez.	Gepr.
Gez.:		Gepr.:		Index
Benennung:		HL Stereo Input Unit 4CH / 8CH		Nummer:
STUDER REGENSDORF ZÜRICH				1.912.240-00

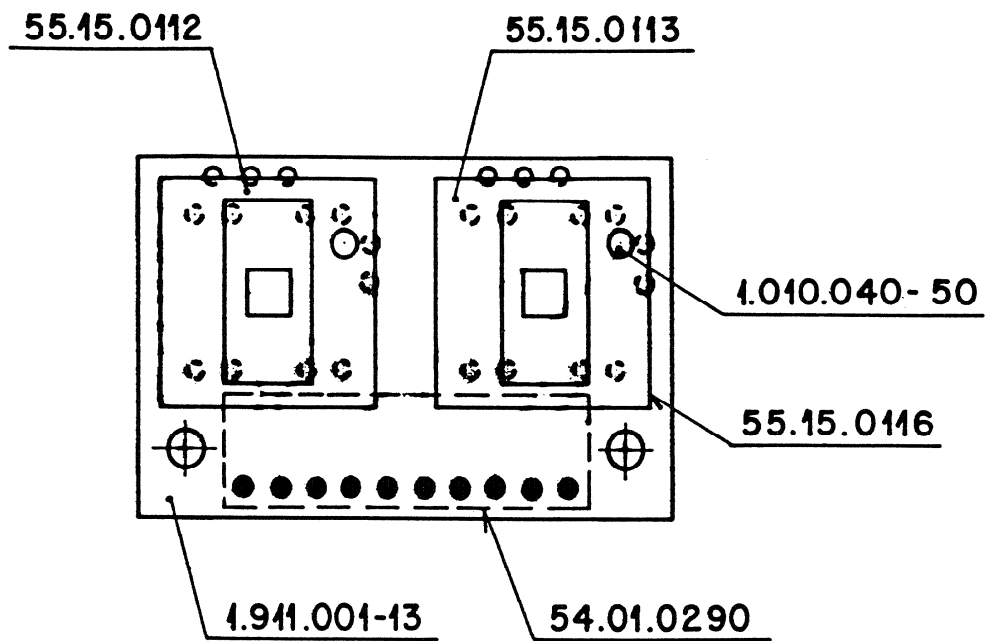

Werkstoff	Norm-Nr.:	Oberfläche	Güte:					③
	DIN-Bez.:		Beh.:					②
	Abmessung:						①	
Zugehörige Unterlagen:		Freimasstoleranz:	Maßstab:	19.5.82	Ho	W		⑤
		±	2:1	Datum	Gez.	Gepr.	Ges.	Index
Ersatz für:		Ersetzt durch:		Kopie für:				
STUDER REGENSDORF ZÜRICH		Benennung: Pushbutton Board N-L		Nummer: 1.911.003-00				

IND	POS NO	PART NO	VALUE	SPECIFICATIONS/EQUIVALENT	MFR
	A101	1.911.003.00		PUSHBUTTON BOARD	ST
	102	1.911.198.00		CONNECTING CABLE 2	"
	103	1.911.199.00		" " 1	"
1	104	1.912.291.00		EQUALIZER BOARD OPTION 1	"

IND	POS NO	PART NO	VALUE	SPECIFICATIONS/EQUIVALENT	MFR
	C.01	59.05.1681	680 p	1% 500V PP	
	.02	59.05.1681	680 p	1% 500V PP	
	.03	59.05.1681	680 p	1% 500V PP	
	.04	59.05.1681	680 p	1% 500V PP	
	.05	59.06.0103	10 n	10% 63V PE	
	.06	59.34.2220	22 p	CER	
	.07	59.22.4101	100 μ	16V EL	
	.08	59.22.2221	220 μ	63V EL	
	.09	59.06.0682	6,8 n	63V PE	
	.12	59.34.2220	22 p	CER	
	.13	59.22.4101	100 μ	16V EL	
	.14	59.22.4101	100 μ	16V "	
	.15	59.22.4101	100 μ	16V "	
	.18	59.34.2220	22 p	CER	
	.19	59.22.4101	100 μ	16V EL	
	.20	59.22.4101	100 μ	16V EL	
	.22	59.34.2220	22 p	CER	
	.23	59.22.4101	100 μ	16V EL	
	.24	59.22.4101	100 μ	16V EL	
	.26	59.34.2220	22 p	CER	
	.27	59.22.4101	100 μ	16V EL	
	.28	59.06.0682	6,8 n	10% 63V PE	
	.29	59.06.0682	6,8 n	" " "	
1	.30	59.06.0682	6,8 n	" " " *	

IND	DATE	NAME		
④	11.12.84	⑤ 11.4.85 1/2	OPTION 1	4CH/FILTER: 1.912.240.00
③	4.10.84	1/2	with Filter	4CH : 1.912.241.00
②	11.5.84	1/2		8CH/FILTER: 1.912.242.00
①	9.2.84	1/2		8CH : 1.912.243.00
○	12.6.82	TAMAS 1/2	ST: STUDER	

STUDER HL ST INPUT UNIT 4CH/FILTER PL 1.912.240.00 PAGE 1 OF 13

IND	DATE	NAME		
④	11.12.84	⑤ 11.4.85 1/2	CER: CERAMIC	
③	4.10.84	1/2	EL: ELECTROLYTIC	
②	11.5.84	1/2	PE: POLYESTER	
①	9.2.84	1/2	PP: POLYPROPYLEN	* only 8 CH
○	12.6.82	TAMAS 1/2		

STUDER HL ST INPUT UNIT 4CH/FILTER PL 1.912.240.00 PAGE 2 OF 13

IND	POS NO	PART NO	VALUE	SPECIFICATIONS/EQUIVALENT	MFR
1	C.31	59.06.0682	6,8 n	63V PE *	
	.32	59.06.0682	6,8 n	63V PE	
	.33	59.06.0682	6,8 n	63V PE	
	C304	59.34.1100	10 p	CER	
	305	59.30.4100	10 μ	16V EL	
	306	59.34.1100	10 p	CER	
	307	59.06.0682	6,8 n	63V PE	
	308	59.06.0682	6,8 n	63V PE	
	309	59.22.4101	100 μ	16V EL	
	310	59.22.4101	100 μ	" "	
	311	59.22.5101	100 μ	25V "	
	312	59.22.4101	100 μ	16V "	
	313	59.26.9109	1 μ	6V SAL	
	315	59.06.0223	22 n	63V PE	
3	319	59.34.4101	100 p	CER	
2	321	59.06.0682	6,8 n	63V PE	

IND	POS NO	PART NO	VALUE	SPECIFICATIONS/EQUIVALENT	MFR
	D.01	50.04.0125	1N4448		
	.02	50.04.0125	1N4448		
	.03	50.04.0125	1N4448		
1	104	50.04.0125	1N4448		*
	105	50.04.0125	1N4448		
	106	50.04.0125	1N4448		
1	107	50.04.0125	1N4448		*
	.08	50.04.0125	1N4448		
	.09	50.04.0125	1N4448		
	D301	50.04.0125	1N4448		
	302	50.04.0125	1N4448		
	303	50.04.0125	1N4448		
	304	50.04.0125	1N4448		
	305	50.04.0125	1N4448		
	306	50.04.0125	1N4448		
	307	50.04.0125	1N4448		
	308	50.04.1112	Z 5V1	400mW	
	309	50.04.0125	1N4448		
	D301	1.010.040.50	COY 41 NA		ST
	302	1.010.040.50	COY 41 NA		ST
	303	50.04.2111	MV 5753		

IND	DATE	NAME		
④	11.12.84	⑤ 11.4.85 1/2	CER: CERAMIC	
③	4.10.84	1/2	EL: ELECTROLYTIC	
②	11.5.84	1/2	PE: POLYESTER	
①	9.2.84	1/2	SAL: SOLID ALUMINILUM	* only 8CH
○	12.6.82	TAMAS 1/2		

STUDER HL ST INPUT UNIT 4CH/FILTER PL 1.912.240.00 PAGE 3 OF 13

IND	DATE	NAME		
④	11.12.84	⑤ 11.4.85 1/2	ST: STUDER	
③	4.10.84	1/2		
②	11.5.84	1/2		
①	9.2.84	1/2		
○	12.6.82	TAMAS 1/2		

STUDER HL ST INPUT UNIT 4CH/FILTER PL 1.912.240.00 PAGE 4 OF 13

IND	POS NO	PART NO	VALUE	SPECIFICATIONS/EQUIVALENT	MFR
	IC .01	50.09.0106	NE 5532	LN DUAL OP-AMP	SIG
	.02	50.05.0243	NE 5534	OP-AMP	"
	.03	50.05.0243	NE 5534	"	"
	.04	50.05.0243	NE 5534	"	"
	.05	50.05.0243	NE 5534	"	"
	IC 301	50.09.0103	TL 071	FET OP-AMP LF 351	TI
	302	50.07.0012	4025	3-IN NOR GATE MOS	MOT,FC
	303	50.07.0049	4049	HEX INV. BUFFER MOS	" "
	304	50.07.0027	4027	DUAL J-K FF MOS	" "
	305	50.05.0156	555	TIMER	SIG,NE
	306	50.05.0243	NE 5534	OP-AMP	SIG
	JS .01	54.01.0020	PIN		
		54.01.0021	JUMPER		
	K .01	56.04.0146	NF-4E-6V		
	P 3	54.11.2007	2 * 8	1/2 ELURO B-TYPE	BU
	4	54.01.0359	2 * 16	ELURO B-TYPE	"
	6	54.01.0359	2 * 16	ELURO B-TYPE	"

IND	DATE	NAME		
①	11.12.84	⑤ 11.4.85	SIG : SIGNETICS	BU: BURNDY
③	4.10.84	④	TI : TEXAS INSTRUMENT	
②	11.5.84	⑥	MOT: MOTOROLA	LN: LOW NOISE
①	9.2.84	⑦	FC : FAIRCHILD	
①	21.6.82	TAMAS	NS : NATIONAL SEMICONDUCTORS	
STUDER HL ST INPUT UNIT 4CH/FILTER PL 1.912.240.00 PAGE 5 OF 13				

IND	POS NO	PART NO	VALUE	SPECIFICATIONS/EQUIVALENT	MFR
5	Q .01	50.03.0216	J 111		SX
	.02	50.03.0350	J 112		"
	.03	50.03.0350	J 112		"
	.04	50.03.0350	J 112		"
	.05	50.03.0350	J 112		"
	.06	50.03.0350	J 112		"
1	.07	50.03.0350	J 112		*
1	.08	50.03.0350	J 112		*
1	.09	50.03.0350	J 112		*
1	.10	50.03.0350	J 112		*
	.11	50.03.0350	J 112		"
	.12	50.03.0350	J 112		"
	.13	50.03.0350	J 112		"
	Q 301	50.03.0350	J 112		SX
	302	50.03.0350	J 112		SX
	303	50.03.0515	BC 307	PNP	BC 557
	304	50.03.0350	J 112		SX
	305	50.03.0436	BC 237	NPN	BC 547

IND	DATE	NAME		
①	11.12.84	⑤ 11.4.85	SX : SILICONIX	
③	4.10.84	④		
②	11.5.84	⑥		
①	9.2.84	⑦		
①	21.6.82	TAMAS		* only 8CH
STUDER HL ST INPUT UNIT 4CH/FILTER PL 1.912.240.00 PAGE 6 OF 13				

IND	POS NO	PART NO	VALUE	SPECIFICATIONS/EQUIVALENT	MFR
	R .01	57.11.3152	15 k	1%	
	.02	.3392	39 k	1%	
	.03	.3152	45 k	1%	
	.04	.3392	39 k	1%	
	.05	.3152	45 k	1%	
	.06	.3392	39 k	1%	
	.07	.3152	45 k	1%	
	.08	.3392	39 k	1%	
	.09	.4152	45 k	2%	
	.10	.3752	75 k	2%	
	.11	.4181	180 Ω	2%	
	.12	.3752	75 k	2%	
	.13	.4271	270 Ω		
	.14	58.01.8102	1 k	TRIM	
	.15	57.11.4272	27 k		
	.16	57.11.4152	45 k		
	.17	1.912.001.32	10 k	2 x 10k LIN POT	ST
	.18	57.11.4152	45 k		
	.19	.4222	22 k		
	.20	.3362	36 k	2%	
	.21	.3162	45 k	2%	
5	.22	.5106	10 M		
	.23	.4222	22 k		
	.24	.4472	47 k		
	.25	.3113	45 k	2%	
5	.26	.5106	10 M		
	.27	.4223	22 k		
1	.28	.4330	33 Ω	OPTION 1 replaced by link	
	.29	.4153	45 k		
	.30	.4223	22 k		

IND	DATE	NAME		
①	11.12.84	⑤ 11.4.85	ST : STUDER	
③	4.10.84	④		
②	11.5.84	⑥	OPTION 1 with Filter	
①	9.2.84	⑦		
①	21.6.82	TAMAS		
STUDER HL ST INPUT UNIT 4CH/FILTER PL 1.912.240.00 PAGE 7 OF 13				

IND	POS NO	PART NO	VALUE	SPECIFICATIONS/EQUIVALENT	MFR
	R .31	57.11.4682	68 k		
	.132	1.912.001.35	10 k	POS. LOG. } POT	ST
	.232		10 k	NEG. LOG. }	
	.33	57.11.3132	1.3 k		
	.34	.4332	33 k		
	.35	.4472	47 k		
	.36	.4333	33 k		
	.37	.4472	47 k		
	.38	.4472	47 k		
	.39	.4332	33 k		
	.40	.4333	33 k		
	.41	.4332	33 k		
	.42	.4332	33 k		
	.43	.4333	33 k		
	.44	1.912.001.44	10 k	2 x 10k POS. LOG. POT	ST
	.45	57.11.4332	33 k		
	.46	.4333	33 k		
	.47	.4332	33 k		
	.148	.4104	100 k		
5	.49	.5106	10 M		
5	.50	.5106	10 M		
	.51	.4333	33 k		
	.52	.4332	33 k		
	.153	.4104	100 k		
5	.54	.5106	10 M		
5	.55	.5106	10 M		
1	.56	.4333	33 k	*	
1	.57	.4332	33 k	*	
1	.158	.4104	100 k	*	
5	.59	.5106	10 M	*	

IND	DATE	NAME		
①	11.12.84	⑤ 11.4.85	ST : STUDER	
③	4.10.84	④		
②	11.5.84	⑥		
①	9.2.84	⑦		
①	21.6.82	TAMAS		* only 8CH
STUDER HL ST INPUT UNIT 4CH/FILTER PL 1.912.240.00 PAGE 8 OF 13				

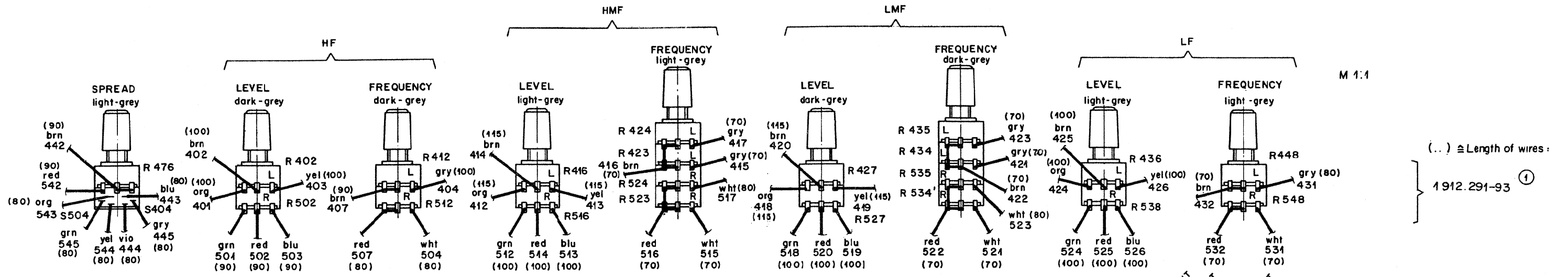

M 1:1

(...) ≙ Length of wires:
1.912.291-93 ①

1.912.291-94 ①

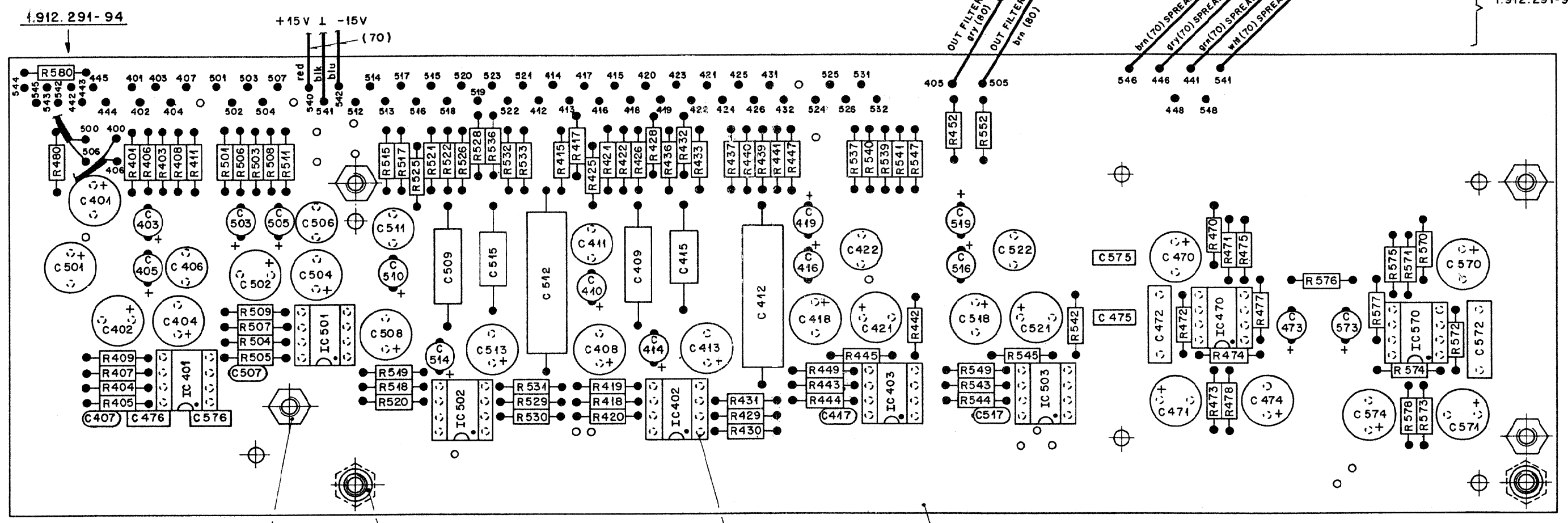

21.01.0354 (4x)
24.16.4030 (4x)
1.010.041-27 (4x)

1.010.040-22 (2x) ②

53.03.0166 (8x)

1.912.291-12

Werkstoff	Norm-Nr.:	Güte:	Anderung	③
	DIN-Bez.:			12.9.85 A.Ho. <i>mls mls</i> ②
Zugehörige Unterlagen:	Abmessung:	Freimasstoleranz:	Maßstab:	22.5.84 STJ <i>Vr Vr</i> ①
	PL			1:1; 2:1
Ersatz für:	Ersetzt durch:	Ausgabe		Datum
Kopie für:		Gez. Gepr. Ges. Index		
STUDER REGENSDORF ZÜRICH		Benennung		1.912.291-00
		Equalizer Board		Nummer: